

Dimensioni in millimetri. *Dimensions shown in millimetres.*

Dati generali *General data*

Dati tecnici *Technical data*

N. poli	2 3 4 5 6	<i>N. poles</i>
Terminali	vite/perforazione <i>screw/piercing</i>	<i>Terminals</i>
Sezione cavo	max 4.0 mm ² (bussola cieca <i>end barrier terminals</i>) max 2.5 mm ² (bussola WP <i>WP terminals</i>) 0.5 mm ² - 1.5 mm ² (bussola a perforazione <i>piercing clip terminals</i>)	<i>Cable section</i>
Diametro cavo min-max ⁽¹⁾	7.0 mm - 17.0 mm	<i>Cable diameter min-max ⁽¹⁾</i>
Grado di protezione (IP)	IP68 5 bar (50 m / 1 h)	<i>Degree of protection (IP)</i>
Corrente e tensione nominale	32A 450V (bussola cieca <i>end barrier terminals</i>) 24A 450V (bussola WP <i>WP terminals</i>) 17.5A 450V (bussola a perforazione <i>piercing clip terminals</i>)	<i>Rated current and voltage</i>
T marking	T85°C	<i>T marking</i>
Temperatura di funzionamento	-40°C to +125°C	<i>Operating temperature</i>
Indice di tracking	PTI 250	<i>Tracking index</i>
Materie prime <i>Raw materials</i>		
Canotto esterno	PA66 GF UL94 V0 GWT 960°C nero <i>black</i> - grigio <i>grey</i> RAL 7035	<i>Connector housing</i>
Pressacavi	PA6 UL94 V2 GWT 850°C nero <i>black</i> - grigio <i>grey</i> RAL 7035	<i>Cable glands</i>
Corpo plastico morsettiera	PA66 GF UL94 V0 GWT 960°C nero <i>black</i> - marrone <i>brown</i>	<i>Terminal block housing</i>
Gommini di tenuta cavo	TPE CR/NBR	<i>Grommets</i>
Guarnizioni	silicone <i>silicon</i>	<i>Seals</i>
Bussole	ottone nichelato <i>brass nickel plated</i>	<i>Contact screw terminals</i>
Viti/Perforazione	M3 acciaio zincato passivato/ottonato <i>steel zinc plated/brass plated</i>	<i>Screws/Piercing</i>

Norme *Standards*

EN60529:1991+A1:2000 EN60998-1:2004 EN60998-2-1:2004

Note: Per cavi $\varnothing \leq 7.0$ mm si consiglia l'utilizzo dell'accessorio codice 6000087LF. *For cable $\varnothing \leq 7.0$ mm it is recommended to use the accessory code 6000087LF.*

Eventuali modifiche e migliorie sui dati tecnici o sul prodotto potranno essere effettuate senza preavviso.
All technical data or other eventual product modifications and improvements can be carried out without notice.

TH400 PATENTED

CONNESSIONE LINEARE FISSA AD ALTA PROTEZIONE. 2-3-4-5-6 POLI.
IN-LINE HIGH PROTECTION WATERPROOF CONNECTOR. 2-3-4-5-6 POLES.

TH400

Codice Order number

versione version	n. poli n. poles	bussola contact terminal	pz/imb pcs/box	codice order number
<p>IP68 5 BAR max voltage 450 V max current 32 A</p>	2		200	THB.400. C1B
			200	THB.400. C3B
	3		200	THB.400. C1A
			200	THB.400. C3A
	4		200	THB.400. D1G new
			200	THB.400. D3G new
<p>IP68 5 BAR max voltage 450 V max current 32 A</p>	5		200	THB.400. D1H
			200	THB.400. D3H
	6		200	THB.400. D1L
			200	THB.400. D3L
	2		200	THB.400. D1M
			200	THB.400. D3M
	3		200	THB.400. D1N
			200	THB.400. D3N
	4		200	THB.400. D1B new
			200	THB.400. D3B new
	5		200	THB.400. D1A
			200	THB.400. D3A
6		200	THB.400. D1D	
		200	THB.400. D3D	
Le versioni sopra indicate sono disponibili con terminali a perforazione di isolante. The above versions are available with piercing clip terminal blocks.			200	THP.400.X1X
Note: Bussola cieca <i>End barrier contact</i> Bussola WP per sezione cavo <i>WP contact for cable section < 1.0 mm²</i> Bussola a perforazione max 1.5 mm² <i>Piercing clip terminals max 1.5 mm²</i>				

Eventuali modifiche e migliorie sui dati tecnici o sul prodotto potranno essere effettuate senza preavviso.
All technical data or other eventual product modifications and improvements can be carried out without notice.

Varianti Options

Colore Colour Contatta il Servizio Clienti per maggiori informazioni. *Contact our Customer Service for availability.*

versione version	codice order number
<input checked="" type="checkbox"/> grigio grey RAL 7035	THX.400.XXX.CG
<input type="checkbox"/> altri colori other colours	THX.400.XXX.CX

Kit di fornitura Purchasing kit

versione version	misure imballaggio box dimensions	contenuto contents	pz/imb pcs/box	codice order number
kit non assemblato unassembled kit	C05 (395x395x185 mm)		200	THX.400.CXX
	C07 (590x390x240 mm)			THX.400.DXX
kit assemblato assembled kit	C05 (395x395x185 mm)		200	THX.400.CXX.Z
	C07 (590x390x240 mm)			THX.400.DXX.Z
kit imbustato retail pack kit Consulta il catalogo Rivenditori. See the Retailers catalogue.	--		--	THX.400.XXX.R
versione speciale custom version	*	*	*	THX.400.XXX.K

Note: Per maggiori informazioni sugli accessori consulta pagina 120. Per maggiori informazioni sulle istruzioni di assemblaggio consulta www.techno.it.
For more information about accessories see page 120. For more information about assembling instructions see www.techno.it.

*** Sono possibili personalizzazioni di prodotto e progetti su richieste specifiche. Contatta il Servizio Clienti.**
Personalization and new custom products are possible. Please contact our Customer Service.

Eventuali modifiche e migliorie sui dati tecnici o sul prodotto potranno essere effettuate senza preavviso.
All technical data or other eventual product modifications and improvements can be carried out without notice.

Caratteristiche e vantaggi Features and benefits



Connessioni protette all'acqua affidabili e ispezionabili, non necessitano l'utilizzo di gel/resina.
High protection waterproof reliable connectors. Avoid the use of gel/resin. Inspection of inner connector possible.



Cablaggio rapido e intuitivo con morsettiere circolari modulari e compatte fino a 6 poli.
Quick and easy installation with compact modular circular connectors up to 6 poles.

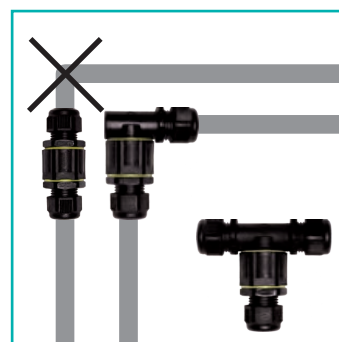

Utilizzabili in ogni situazione. La versione a L, ad esempio, garantisce la corretta piegatura del cavo.
Usable in every situation of installation. The "L" type connector, for instance, ensures the cable is properly folded.



Inserti disponibili in versione:
B) cieca, C) lamella premi cavo, D) perforazione.
Metal inserts available:
B) end-barrier, C) wire-protection, D) piercing.



Innovazione di prodotto. Cablaggio rapido di derivazioni. Si evita di attorcigliare il trefolo.
Product innovation. Fast wiring of electrical derivations. Avoid twisting the top of the wire.



Personalizzabili. Versioni trasparenti e colorate su richiesta del cliente.
Custom products. Transparent and colour versions on customer request.



Massima versatilità. Possibilità di combinare prodotti di famiglie differenti per ottenere soluzioni ibride.
Maximum versatility. Combinations of different types of product to generate hybrid solutions.



Compatibilità con guaine corrugate, guida cavi e calze espandibili.
Fitting with braided hose, spiral top and cable protection systems.



Protezione dalla condensa con resina ad alto potere isolante, garantisce l'integrità degli apparecchi nel tempo.
Protection from moisture condensation with a special resin with excellent insulation capacity, ensures integrity of equipments over time.

Eventuali modifiche e migliorie sui dati tecnici o sul prodotto potranno essere effettuate senza preavviso.
All technical data or other eventual product modifications and improvements can be carried out without notice.

new

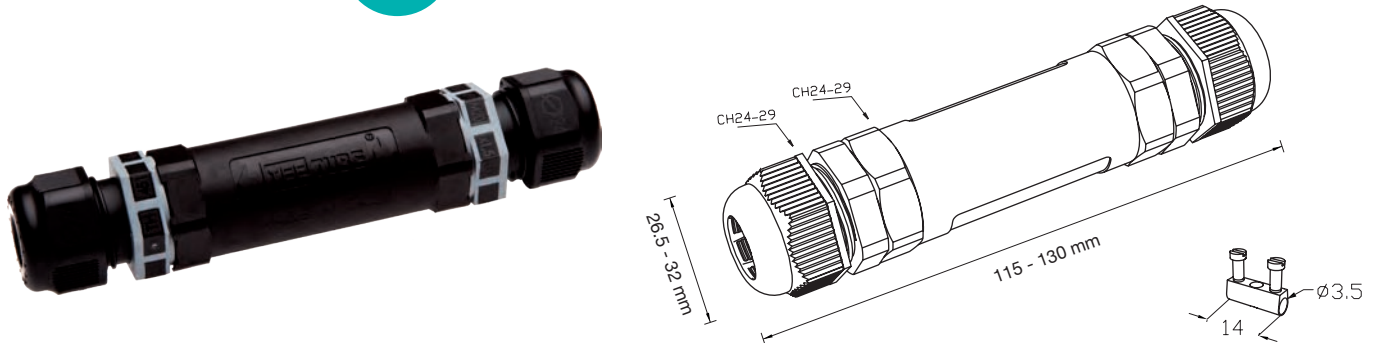
CE  03 **RoHS** Dimensioni in millimetri. *Dimensions shown in millimetres.***Dati generali** *General data***Dati tecnici** *Technical data*

N. poli	2	3	4	5	6	N. poles
Terminali	vite/perforazione <i>screw/piercing</i>					Terminali
Sezione cavo	max 4.0 mm ² (bussola cieca <i>end barrier terminals</i>) max 2.5 mm ² (bussola WP <i>WP terminals</i>) 0.5 mm ² - 1.5 mm ² (bussola a perforazione <i>piercing clip terminals</i>)					Cable section
Diametro cavo min-max ⁽¹⁾	7.0 mm - 17.0 mm					Cable diameter min-max ⁽¹⁾
Grado di protezione (IP)	IP68 5 bar (50 m / 1 h)					Degree of protection (IP)
Corrente e tensione nominale	32A 450V (bussola cieca <i>end barrier terminals</i>) 24A 450V (bussola WP <i>WP terminals</i>) 17.5A 450V (bussola a perforazione <i>piercing clip terminals</i>)					Rated current and voltage
T marking	T125°C					T marking
Temperatura di funzionamento	-40°C to +125°C					Operating temperature
Indice di tracking	PTI 250					Tracking index

Materie prime *Raw materials*

Canotto esterno	PA66 GF UL94 V0 GWT 960°C nero <i>black</i> - grigio <i>grey</i> RAL 7035	Connector housing
Pressacavi	PA6 UL94 V2 GWT 850°C nero <i>black</i> - grigio <i>grey</i> RAL 7035	Cable glands
Corpo plastico morsettiera	PA66 GF UL94 V0 GWT 960°C nero <i>black</i> - marrone <i>brown</i>	Terminal block housing
Guarnizioni co-stampate	TPE gomma <i>rubber</i> grigio <i>grey</i> RAL 7035	Co-moulded seals
Bussole	ottone nichelato <i>brass nickel plated</i>	Contact screw terminals
Viti/Perforazione	M3 acciaio zincato passivato/ot-tonato <i>steel zinc plated/brass plated</i>	Screws/Piercing

Norme Standards

EN60529:1991+A1:2000 EN60998-1:2004 EN60998-2-1:2004

Note: Per cavi $\varnothing \leq 7.0$ mm si consiglia l'utilizzo dell'accessorio codice 6000087LF. *For cable $\varnothing \leq 7.0$ mm it is recommended to use the accessory code 6000087LF.*Eventuali modifiche e migliorie sui dati tecnici o sul prodotto potranno essere effettuate senza preavviso.
All technical data or other eventual product modifications and improvements can be carried out without notice.

TH400 PATENTED

CONNESSIONE LINEARE FISSA AD ALTA PROTEZIONE CON PRESSACAVO INNOVATIVO.
IN-LINE HIGH PROTECTION CONNECTOR WITH INNOVATIVE CABLE GLAND.

TH400







Codice Order number

versione version	n. poli n. poles	bussola contact terminal	Ø min-max cavo Ø cable min-max	pz/imb pcs/box	codice order number
<p>IP68 5 BAR max voltage 450 V max current 32 A Ø cable 7.0-14.0 mm</p>	2		A 7.0 mm - 10.5 mm B 7.0 mm - 10.5 mm	200	THB.400. E2A.1
			A 7.0 mm - 10.5 mm B 10.5 mm - 14.0 mm	200	THB.400. E2A.2
		A 10.5 mm - 14.0 mm B 10.5 mm - 14.0 mm	200	THB.400. E2A.3	
		A 7.0 mm - 10.5 mm B 7.0 mm - 10.5 mm	200	THB.400. E2C.1	
		A 7.0 mm - 10.5 mm B 10.5 mm - 14.0 mm	200	THB.400. E2C.2	
		A 10.5 mm - 14.0 mm B 10.5 mm - 14.0 mm	200	THB.400. E2C.3	
	3		A 7.0 mm - 10.5 mm B 7.0 mm - 10.5 mm	200	THB.400. E3A.1
			A 7.0 mm - 10.5 mm B 10.5 mm - 14.0 mm	200	THB.400. E3A.2
		A 10.5 mm - 14.0 mm B 10.5 mm - 14.0 mm	200	THB.400. E3A.3	
		A 7.0 mm - 10.5 mm B 7.0 mm - 10.5 mm	200	THB.400. E3C.1	
		A 7.0 mm - 10.5 mm B 10.5 mm - 14.0 mm	200	THB.400. E3C.2	
		A 10.5 mm - 14.0 mm B 10.5 mm - 14.0 mm	200	THB.400. E3C.3	
<p>IP68 5 BAR max voltage 450 V max current 32 A Ø cable 7.0-17.0 mm</p>	2		A 7.0 mm - 10.5 mm B 7.0 mm - 10.5 mm	200	THB.400. F2A.1
			A 7.0 mm - 10.5 mm B 10.5 mm - 14.0 mm	200	THB.400. F2A.2
		A 7.0 mm - 10.5 mm B 14.0 mm - 17.0 mm	200	THB.400. F2A.3	
		A 10.5 mm - 14.0 mm B 10.5 mm - 14.0 mm	200	THB.400. F2A.4	
		A 10.5 mm - 14.0 mm B 14.0 mm - 17.0 mm	200	THB.400. F2A.5	
		A 14.0 mm - 17.0 mm B 14.0 mm - 17.0 mm	200	THB.400. F2A.6	
		A 7.0 mm - 10.5 mm B 7.0 mm - 10.5 mm	200	THB.400. F2C.1	
		A 7.0 mm - 10.5 mm B 10.5 mm - 14.0 mm	200	THB.400. F2C.2	
		A 7.0 mm - 10.5 mm B 14.0 mm - 17.0 mm	200	THB.400. F2C.3	
		A 10.5 mm - 14.0 mm B 10.5 mm - 14.0 mm	200	THB.400. F2C.4	
		A 10.5 mm - 14.0 mm B 14.0 mm - 17.0 mm	200	THB.400. F2C.5	
		A 14.0 mm - 17.0 mm B 14.0 mm - 17.0 mm	200	THB.400. F2C.6	
	3		A 7.0 mm - 10.5 mm B 7.0 mm - 10.5 mm	200	THB.400. F3A.1
			A 7.0 mm - 10.5 mm B 10.5 mm - 14.0 mm	200	THB.400. F3A.2
		A 7.0 mm - 10.5 mm B 14.0 mm - 17.0 mm	200	THB.400. F3A.3	
		A 10.5 mm - 14.0 mm B 10.5 mm - 14.0 mm	200	THB.400. F3A.4	
		A 10.5 mm - 14.0 mm B 14.0 mm - 17.0 mm	200	THB.400. F3A.5	
		A 14.0 mm - 17.0 mm B 14.0 mm - 17.0 mm	200	THB.400. F3A.6	

Note: Bussola cieca End barrier contact Bussola WP per sezione cavo WP contact for cable section < 1.0 mm²

Eventuali modifiche e migliorie sui dati tecnici o sul prodotto potranno essere effettuate senza preavviso.
All technical data or other eventual product modifications and improvements can be carried out without notice.

Codice Order number

versione version	n. poli n. poles	bussola contact terminal	Ø min-max cavo Ø cable min-max	pz/imb pcs/box	codice order number
 <div style="border: 1px solid black; padding: 5px; width: fit-content; margin: 10px auto;"> <p>IP68 5 BAR max voltage 450 V max current 32 A Ø cable 7.0-17.0 mm</p> </div>	3		A 7.0 mm - 10.5 mm B 7.0 mm - 10.5 mm	200	THB.400. F3C.1
			A 7.0 mm - 10.5 mm B 10.5 mm - 14.0 mm	200	THB.400. F3C.2
			A 7.0 mm - 10.5 mm B 14.0 mm - 17.0 mm	200	THB.400. F3C.3
			A 10.5 mm - 14.0 mm B 10.5 mm - 14.0 mm	200	THB.400. F3C.4
			A 10.5 mm - 14.0 mm B 14.0 mm - 17.0 mm	200	THB.400. F3C.5
			A 14.0 mm - 17.0 mm B 14.0 mm - 17.0 mm	200	THB.400. F3C.6
	4		A 7.0 mm - 10.5 mm B 7.0 mm - 10.5 mm	200	THB.400. F4A.1
			A 7.0 mm - 10.5 mm B 10.5 mm - 14.0 mm	200	THB.400. F4A.2
			A 7.0 mm - 10.5 mm B 14.0 mm - 17.0 mm	200	THB.400. F4A.3
			A 10.5 mm - 14.0 mm B 10.5 mm - 14.0 mm	200	THB.400. F4A.4
			A 10.5 mm - 14.0 mm B 14.0 mm - 17.0 mm	200	THB.400. F4A.5
			A 14.0 mm - 17.0 mm B 14.0 mm - 17.0 mm	200	THB.400. F4A.6
		A 7.0 mm - 10.5 mm B 7.0 mm - 10.5 mm	200	THB.400. F4C.1	
		A 7.0 mm - 10.5 mm B 10.5 mm - 14.0 mm	200	THB.400. F4C.2	
		A 7.0 mm - 10.5 mm B 14.0 mm - 17.0 mm	200	THB.400. F4C.3	
		A 10.5 mm - 14.0 mm B 10.5 mm - 14.0 mm	200	THB.400. F4C.4	
		A 10.5 mm - 14.0 mm B 14.0 mm - 17.0 mm	200	THB.400. F4C.5	
		A 14.0 mm - 17.0 mm B 14.0 mm - 17.0 mm	200	THB.400. F4C.6	
5		A 7.0 mm - 10.5 mm B 7.0 mm - 10.5 mm	200	THB.400. F5A.1	
		A 7.0 mm - 10.5 mm B 10.5 mm - 14.0 mm	200	THB.400. F5A.2	
		A 7.0 mm - 10.5 mm B 14.0 mm - 17.0 mm	200	THB.400. F5A.3	
		A 10.5 mm - 14.0 mm B 10.5 mm - 14.0 mm	200	THB.400. F5A.4	
		A 10.5 mm - 14.0 mm B 14.0 mm - 17.0 mm	200	THB.400. F5A.5	
		A 14.0 mm - 17.0 mm B 14.0 mm - 17.0 mm	200	THB.400. F5A.6	
		A 7.0 mm - 10.5 mm B 7.0 mm - 10.5 mm	200	THB.400. F5C.1	
		A 7.0 mm - 10.5 mm B 10.5 mm - 14.0 mm	200	THB.400. F5C.2	
		A 7.0 mm - 10.5 mm B 14.0 mm - 17.0 mm	200	THB.400. F5C.3	
		A 10.5 mm - 14.0 mm B 10.5 mm - 14.0 mm	200	THB.400. F5C.4	
		A 10.5 mm - 14.0 mm B 14.0 mm - 17.0 mm	200	THB.400. F5C.5	
		A 14.0 mm - 17.0 mm B 14.0 mm - 17.0 mm	200	THB.400. F5C.6	

Note:  Bussola cieca End barrier contact  Bussola WP per sezione cavo WP contact for cable section < 1.0 mm²





Eventuali modifiche e migliorie sui dati tecnici o sul prodotto potranno essere effettuate senza preavviso.
All technical data or other eventual product modifications and improvements can be carried out without notice.

TH400 PATENTED

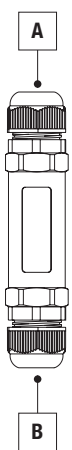

CONNESSIONE LINEARE FISSA AD ALTA PROTEZIONE CON PRESSACAVO INNOVATIVO.
IN-LINE HIGH PROTECTION CONNECTOR WITH INNOVATIVE CABLE GLAND.

TH400

Codice Order number

versione version	n. poli n. poles	bussola contact terminal	Ø min-max cavo Ø cable min-max	pz/imb pcs/box	codice order number
 <div style="border: 1px solid black; padding: 5px; width: fit-content; margin: 10px auto;"> IP68 5 BAR max voltage 450 V max current 32 A Ø cable 7.0-17.0 mm </div>	6		A 7.0 mm - 10.5 mm B 7.0 mm - 10.5 mm	200	THB.400.F6A.1
			A 7.0 mm - 10.5 mm B 10.5 mm - 14.0 mm	200	THB.400.F6A.2
			A 7.0 mm - 10.5 mm B 14.0 mm - 17.0 mm	200	THB.400.F6A.3
			A 10.5 mm - 14.0 mm B 10.5 mm - 14.0 mm	200	THB.400.F6A.4
			A 10.5 mm - 14.0 mm B 14.0 mm - 17.0 mm	200	THB.400.F6A.5
			A 14.0 mm - 17.0 mm B 14.0 mm - 17.0 mm	200	THB.400.F6A.6
			A 7.0 mm - 10.5 mm B 7.0 mm - 10.5 mm	200	THB.400.F6C.1
			A 7.0 mm - 10.5 mm B 10.5 mm - 14.0 mm	200	THB.400.F6C.2
			A 7.0 mm - 10.5 mm B 14.0 mm - 17.0 mm	200	THB.400.F6C.3
			A 10.5 mm - 14.0 mm B 10.5 mm - 14.0 mm	200	THB.400.F6C.4
			A 10.5 mm - 14.0 mm B 14.0 mm - 17.0 mm	200	THB.400.F6C.5
			A 14.0 mm - 17.0 mm B 14.0 mm - 17.0 mm	200	THB.400.F6C.6
				200	THP.400.XXA.X

Le versioni sopra indicate sono disponibili con terminali a perforazione di isolante.
The above versions are available with piercing clip terminal blocks.

Note:  Bussola cieca End barrier contact  Bussola WP per sezione cavo WP contact for cable section < 1.0 mm²
 Bussola a perforazione max 1.5 mm² Piercing clip terminals max 1.5 mm²

Varianti Options

Colore Colour Contatta il Servizio Clienti per maggiori informazioni. Contact our Customer Service for availability.

versione version	codice order number
<input checked="" type="checkbox"/> grigio grey RAL 7035	THX.400.XXX.X.CG
<input type="checkbox"/> altri colori other colours	THX.400.XXX.X.CX

Kit di fornitura Purchasing kit

versione version	misure imballaggio box dimensions	contenuto contents	pz/imb pcs/box	codice order number
kit non assemblato unassembled kit	C05 (395x395x185 mm)		200	THX.400.EXX.X
	C07 (590x390x240 mm)			THX.400.FXX.X
kit assemblato assembled kit	C05 (395x395x185 mm)		200	THX.400.EXX.X.Z
	C07 (590x390x240 mm)			THX.400.FXX.X.Z
kit imbustato retail pack kit Consulta il catalogo Rivenditori. See the Retailers catalogue.	--		--	THX.400.XXX.X.R
versione speciale custom version	*	*	*	THX.400.XXX.X.K

Note: Per maggiori informazioni sugli accessori consulta pagina 120. Per maggiori informazioni sulle istruzioni di assemblaggio consulta www.techno.it.
For more information about accessories see page 120. For more information about assembling instructions see www.techno.it.

*** Sono possibili personalizzazioni di prodotto e progetti su richieste specifiche. Contatta il Servizio Clienti.**
Personalization and new custom products are possible. Please contact our Customer Service.

Eventuali modifiche e migliorie sui dati tecnici o sul prodotto potranno essere effettuate senza preavviso.
All technical data or other eventual product modifications and improvements can be carried out without notice.